

Effective date:2023-05-17

Status: Approved

# Class Rules

## International J/24 Class



The J/24 was designed in 1976 by Rodney Johnstone and was adopted as a World Sailing class in 1981.

sport / nature / technology

# INDEX

---

## PART I – ADMINISTRATION

### Section A – General

A.1	Language .....	4
A.2	Abbreviations .....	4
A.3	Authorities.....	4
A.4	Administration of the Class .....	4
A.5	Class Rules Changes at Events .	4
A.6	Class Rules Amendments .....	4
A.7	Class Rules Interpretations .....	5
A.8	International Class Fee and Licensed Manufacturers .....	5
A.9	Sail Numbers .....	5
A.10	Class Membership Requirements	5
A.11	Measurement Certificate .....	5
A.12	Initial Hull Certification .....	6
A.13	Validity of Certificate .....	6
A.14	Hull Re-Certification .....	6
A.15	Retention of Certification Documentation.....	6

### Section B – Boat Eligibility

B.1	Class Rules and Certification ....	7
B.2	Class Association Markings .....	7
B.3	Documentation to be carried aboard while racing .....	7
B.4	Event Limitation Mark.....	7

## PART II – REQUIREMENTS AND LIMITATIONS

### Section C – Conditions for Racing

C.1	General .....	8
C.2	Crew .....	8
C.3	Personal Equipment .....	8
C.4	Advertising .....	8
C.5	Portable Equipment .....	9
C.6	Boat .....	10
C.7	Hull .....	11

C.8	Hull Appendages.....	16
C.9	Rig .....	16
C.10	Sails .....	19

### Section D– Hull

D.1	Parts .....	21
D.2	General .....	21
D.3	Hull/Deck Shell .....	25
D.4	Bulkheads .....	25
D.5	Interior Liner .....	25
D.6	Assembled Hull .....	25
D.7	Weights.....	26
D.8	Keel Stub .....	26

### Section E – Hull Appendages

E.1	Parts .....	27
E.2	General .....	27
E.3	Keel .....	28
E.4	Rudder Blade and Tiller .....	28

### Section F – Rig

F.1	Parts .....	30
F.2	General .....	30
F.3	Mast .....	30
F.4	Boom .....	31
F.5	Spinnaker Pole .....	31
F.6	Standing Rigging .....	32
F.7	Running Rigging .....	32

### Section G – Sails

G.1	Parts .....	34
G.2	General .....	34
G.3	Mainsail .....	35
G.4	Headsail - Genoa .....	36
G.5	Headsail - Jib .....	37
G.6	Spinnaker .....	38

## PART III – APPENDICES

### Section H - Event Rule Change

Options .....	39
---------------	----

# INTRODUCTION

---

*This introduction only provides an informal background and the International J/24 Class Rules proper begin on the next page.*

*The J/24 was designed and built by Rodney Johnstone in 1976. The objective was to create a popular design that could be raced and cruised economically by a broad range of crews. The fact that many of the early boats are still racing at the top levels in the class along with the popularity of the J/24 would indicate that this objective has been successfully met. It is the intention of the International J/24 Class to continue that tradition with this conversion of our rules to the World Sailing format.*

*J/24 hulls, hull appendages, mast spars and boom spars shall only be manufactured by builders licensed to do so under the copyright of J Boats, Inc. (557 Thames Street, P.O. Box 90, Newport, RI 02840, USA) – in the class rules referred to as licensed builders. Equipment is required to comply with the International J/24 Building Specification.*

*J/24 sails are measurement controlled to the designated dimensions and may be made by any manufacturer.*

*J/24 hulls, hull appendages, mast spars and boom spars shall, after having left the builder, or sails after certification, only be altered to the extent permitted in Sections C, D and E of the class rules.*

*Rules regulating the use of equipment during a race are contained in Section C of these class rules, in ERS Part I and in the Racing Rules of Sailing.*

PLEASE REMEMBER:

THESE RULES ARE **CLOSED CLASS RULES** WHERE IF IT DOES NOT SPECIFICALLY SAY THAT YOU MAY – THEN YOU SHALL NOT.

COMPONENTS, AND THEIR USE, ARE DEFINED BY THEIR DESCRIPTION.

# PART I – ADMINISTRATION

---

## Section A – General

### A.1 LANGUAGE

- A.1.1 The official language of the class is English and in case of dispute over translation the English text shall prevail.
- A.1.2 The word “shall” is mandatory and the word “may” is permissive.
- A.1.3 **Except where used in headings, when a term is printed in “bold” the definition in the ERS applies and when a term is printed in “*italics*” the definition in the RRS applies.**

### A.2 ABBREVIATIONS

- A.2.1 MNA World Sailing Member National Authority  
ICA International J/24 Class Association  
NCA J/24 National Class Association  
ERS Equipment Rules of Sailing  
RRS Racing Rules of Sailing

### A.3 AUTHORITIES

- A.3.1 The international authority of the class is World Sailing which shall co-operate with the ICA in all matters concerning these **class rules**.
- A.3.2 Notwithstanding anything contained herein, the ICA has the authority to withdraw a measurement **certificate** and shall do so on the request of World Sailing.
- A.3.3 Neither World Sailing, the MNA, the ICA, the NCA nor a class measurer, an international measurer or an **equipment inspector** is under any legal responsibility in respect of these **class rules** for the accuracy of measurement. No claim arising against any of them shall be entertained.
- A.3.4 The Certification Authority for all items except sails is the ICA.

### A.4 ADMINISTRATION OF THE CLASS

- A.4.1 World Sailing has delegated its administrative functions of the class to the ICA. The ICA may delegate part or all of its functions, as stated in these **class rules**, to an NCA.
- A.4.2 In countries where there is no NCA, or the NCA does not wish to administrate the class, its administrative functions as stated in these **class rules** shall be carried out by the ICA which may delegate part or all of the administration functions to the appropriate MNA.

### A.5 CLASS RULES CHANGES AT EVENTS

- A.5.1 Appendix J, Event Rules J.2 – J.5 applies when activated in accordance with RRS 87.

### A.6 CLASS RULES AMENDMENTS

- A.6.1 Amendments to these **class rules** must follow procedures defined in the International J/24 Class Constitution and are subject to the approval of World Sailing in accordance with World Sailing Regulations.

## **A.7 CLASS RULES INTERPRETATIONS**

- A.7.1 Interpretation of **class rules** shall be made by World Sailing, which shall consult with the ICA and J Boats, Inc.
- A.7.2 In the event of discrepancy between any rules, drawings, specifications or measurement forms, the matter shall be referred to World Sailing.
- A.7.3 Any interpretation of **class rules** at an event may be made by the ICA Technical Committee representative at the event or by the Race committee-constituted in accordance with the RRS, Appendix N. Such interpretation shall only be valid during the event and shall, as soon as practical after the event, be referred to World Sailing and the ICA to consider any adjustments that may be necessary going forward.

## **A.8 INTERNATIONAL CLASS FEE AND LICENSED MANUFACTURERS**

- A.8.1 **Hulls, hull appendages and mast and boom spars** may only be manufactured by licensed builders which are licensed by J Boats, Inc. Manufacturing must be in conformance with the building specifications from J Boats, Inc. and these **class rules**, including all plans.
- A.8.2 There is an International Class Fee payable to World Sailing for each new **hull** built. This plaque fee is controlled by an agreement between J Boats, Inc., its licensed builders and World Sailing.
- A.8.3 The licensed **hull** builder shall complete parts B & C of the class measurement form, which shall include both keel weight before assembly and “Builder’s Weight”, and supply that form to the ICA, J Boats, Inc. and the new owner.

## **A.9 SAIL NUMBERS**

- A.9.1 **Sail** numbers shall correspond to the designated portion of the **hull** identification number moulded into the transom of each **boat**, unless otherwise prescribed by the owner’s national authority. When a **boat** is chartered or loaned, the **sail** number of the **boat** may be that of the class member in charge of the **boat**.

## **A.10 CLASS MEMBERSHIP REQUIREMENTS**

- A.10.2 The **boat’s** owner(s) shall be members of their country’s NCA or the ICA.
- A.10.3 The **boat’s** driver shall be a member of his/her country’s NCA or the ICA.

## **A.11 MEASUREMENT CERTIFICATE**

- A.11.1 A Measurement **Certificate** shall record the following information:
- (a) Class
  - (b) **Certification authority** - ICA
  - (c) **Hull** identification Number and related **sail** number
  - (d) Owner and owner’s contact information and signature
  - (e) Builder’s contact information and details in parts B & C
  - (f) Date of issue of **certificate**
  - (g) A list of items that have been checked and passed for **certification**
  - (h) The name(s) of measurer(s) involved in the **certification** process.
  - (i) The Inventory of Required and Optional Equipment that is carried on the **boat** to identify the items included to reach all up weight, C.6.1.
- A.11.2 It is the responsibility of an owner to ensure that the **boat** complies at all times with the current **class rules**. In the event of a charter/loan, it is the owner’s

responsibility to deliver a **class rules** compliant **boat**, and the responsibility of the chartered/borrower to maintain the **boat** in compliance with the **class rules** for the duration of the charter

## **A.12 INITIAL HULL CERTIFICATION**

- A.12.1 For a measurement certificate to be issued to a **hull** not previously **certified**:
- (a) **Certification measurement** shall be carried out by a class measurer (recognized by the ICA) who shall complete the appropriate documentation.
  - (b) The documentation and **certification** fee, if required, shall be sent to the **Certification Authority (ICA)**.
  - (c) Upon receipt of satisfactorily completed documentation and a **certification** fee, if required, the **certification authority** may issue a **certificate**.

## **A.13 VALIDITY OF CERTIFICATE**

- A.13.1 A hull **certificate** becomes invalid upon
- (a) the change to any items recorded on the hull **certificate** as required under A.11.1 except the Inventory of Required and Optional Equipment (A.11.1(g)).
  - (b) the date of expiry,
  - (c) change of ownership,
  - (d) withdrawal by the **certification authority**,
  - (e) modifications, fairing or repairs beyond what is described in SECTION C
  - (f) the issue of a new **certificate**

## **A.14 HULL RE-CERTIFICATION**

- A.14.1 The **certification authority** may issue a **certificate** to a previously certified **hull**:
- (a) When it is invalidated under A.13.1 (a), (b), (c) or (e), after receipt of a new measurement form and **certification** fee if required.
  - (b) When it is invalidated under A.13.1 (d), at its discretion.

## **A.15 RETENTION OF CERTIFICATION DOCUMENTATION**

- A.15.1 The **Certification Authority** shall retain the original measurement form upon which the current certificate is based. The **Certification Authority** shall also keep a copy of all measurement certificates issued. This may be scanned and kept electronically.

## Section B – Boat Eligibility

For a **boat** to be eligible for *racing*, it shall comply with the rules in this section.

### B.1 CLASS RULES AND CERTIFICATION

B.1.1 The **boat** shall:

- (a) be in compliance with these **class rules**.
- (b) have valid measurement certificate.

### B.2 CLASS ASSOCIATION MARKINGS

B.2.1 There shall be a current J/24 Class membership sticker on the outer face of the transom near the upper starboard corner.

B.2.2 **Sails** shall carry a Class Association Royalty label sewn onto the starboard side of the **sail** near its **tack** or in a spinnaker near the **clew**. Royalty tags shall not be transferred from one **sail** to another.

### B.3 DOCUMENTATION TO BE CARRIED ABOARD WHILE RACING

B.3.1 The **boat's** current Measurement **Certificate**.

B.3.2 A current Inventory of Required and Optional Equipment shall be carried at all times while *racing*. The Inventory of Required and Optional Equipment must match the actual equipment that is being carried at the time. For some regattas, this may include the royalty tag numbers for **sails** and the serial numbers of any **event limitation marks** on any equipment on board. Special forms will be provided for those regattas requiring extra information on this form. The Inventory of Required and Optional Equipment will include the weight of all items included to make up the difference between the basic **boat weight** and the all up weight (C.6.1) as well as the weight of any **corrector weights** required. It is the responsibility of the **boat** owner's or charterer/borrower's (where relevant) responsibility to maintain this form, which is available from the class.

### B.4 EVENT LIMITATION MARKS

B.4.1 **Event Limitation Marks** may be used by **equipment inspectors** to identify equipment that has been inspected for compliance on a particular **boat**. Such inspected and marked equipment shall not be replaced for the duration of the event without permission of the race committee. **Event limitation marks** may use serial numbers on labels with event stamps or may take the form of seals to prevent adjustment of rigging or shims. If serial numbers are used, they shall be recorded on event forms (see B.3.2 above).

# PART II – REQUIREMENTS AND LIMITATIONS

---

The **crew** and the **boat** shall comply with the rules in Part II when *racing*. In case of conflict Section C shall prevail.

The rules in Part II are **closed class rules**. **Certification control** and **equipment inspection** shall be carried out in accordance with the ERS except where varied in this Part.

## Section C – Conditions for Racing

### C.1 GENERAL

#### C.1.1 RULES

- (a) RRS 42.3(b) is modified by adding. The **crew** shall not hang on the **mast** or **shrouds** to promote roll tacking or gybing.

### C.2 CREW

#### C.2.1 LIMITATIONS

- (a) The **crew** shall consist of a minimum of three people and the combined weight (in swim wear) of all crew members shall not exceed 400kg. Weigh is conducted during registration and inspection satisfies this requirement for the duration of the event.
- (b) For an event of 2 or more consecutive days (excluding any lay days) the **crew** shall not be altered. The sailing instructions may change this rule.

#### C.2.2 CREW POSITIONING

RRS 49.2 shall apply to all **crew** except the **headsail** trimmer. The **headsail** trimmer shall be allowed to turn while sitting on the gunwale.

#### C.2.3 LIMITATIONS ON THE DRIVER

The driver at world and continental championship events, and when required by the notice of race, shall be eligible as per the International J/24 Class Regatta Regulations.

### C.3 PERSONAL EQUIPMENT

#### C.3.1 MANDATORY

The **boat** shall be equipped with **personal flotation devices** (PFD) for each **crew** member to the minimum standard ISO 12402-5, (level 50), or USCG Type III, or AUS PFD II or equivalent.

### C.4 ADVERTISING

#### C.4.1 LIMITATIONS

Advertising shall only be displayed in accordance the World Sailing Advertising Code. (See World Sailing Regulation 20).



## C.5 PORTABLE EQUIPMENT

### C.5.1 MANDATORY

#### (a) FOR USE WHILE RACING

- (1) A minimum of one bucket of minimum 9 litres capacity.
- (2) One anchor with optional chain. The anchor and its chain shall weight not less than 6kg nor more than 12kg. Any line not less than 40m and with a minimum of 8mm in diameter shall be attached to the anchor or chain. The anchor shall be secured against movement in the event of capsize.
- (3) A minimum of one fire extinguisher: type and capacity to comply with local regulations.
- (4) A minimum of one lifesaving device on deck and ready to be thrown overboard.
- (5) A first aid kit.
- (6) A minimum of one water resistant flashlight

#### (b) NOT FOR USE WHILE RACING

- (1) One outboard engine/motor of 12 kg. minimum weight empty of fuel. The engine/motor shall be stowed under a quarter berth or aft of the sill of the companionway. Both the engine/motor and its fuel tank/battery shall be secured against movement in the event of capsize. Electric motors shall be weighed with a single battery if the battery is mounted on the motor during use.

### C.5.2 OPTIONAL

#### (a) FOR USE WHILE RACING

- (1) Electronic or mechanical timing devices.
- (2) Any replacement **running rigging** and hardware as might be useful to repair or replace minor damages or equipment failures on the water.
- (3) Tape or other materials to make temporary repairs.
- (4) One spare, **rudder**, one spare tiller, and one spare tiller extension any of which may be substituted on the water without permission of a Race Committee.
- (5) One spare **spinnaker pole** which may be substituted on the water without permission of a Race Committee.
- (6) Foam and/or plastic cushions which may be fitted to the lifelines.
- (7) A maximum of four berth cushions with a maximum total weight of 21kg.
- (8) A companionway step box or ice box located but not attached between the bunks on the cabin sole with an empty weight no more than 14kg.
- (9) Separate containers with no more than 10 litres of drinking water.
- (10) A maximum of one battery capable of powering the electronic devices on board that do not have their own power supply. Battery shall not weigh more than 25kg and shall be secured against movement in the event of capsize.

- (11) Any spinnaker bag positioned below deck to facilitate the launch of the spinnaker through the main companionway.
  - (12) Tool kit.
  - (13) Portable toilet.
  - (14) Handheld VHF radio.
  - (15) Portable music/radio entertainment system.
  - (16) Additional safety devices and equipment to owner's requirements or to comply with local regulations.
  - (17) Cameras and other video recording devices such as cell phones that are handheld or attached to the **boat**.
- (b) NOT FOR USE WHILE RACING
- (1) Fenders and dock lines.
  - (2) Lifting equipment for launching and retrieving the **boat** from the water, all parts of which that are not bolted in the bilge shall be stowed off the cabin sole.

C.5.3 STORAGE OF PORTABLE EQUIPMENT

Unless otherwise stated in these rules, no equipment other than un-bagged sails shall be stored on the cabin sole.

**C.6 BOAT**

C.6.1 WEIGHT

- (a) Boat Weight

	minimum
<b>Boat weight</b> in dry condition	1270 kg
<b>Boat weight</b> in dry condition including all <b>portable equipment</b> and <b>personal equipment</b>	1330 kg

- (b) Boats being weighed for the 1270 kg measurement must reflect the Builder's Weight as specified in parts B & C of the class measurement form.

## C.6.2 CORRECTOR WEIGHTS

- (a) If the **boat weight** is below the minimum established in C.6.1, lead **corrector weights** shall be permanently fastened as shown in diagram below.

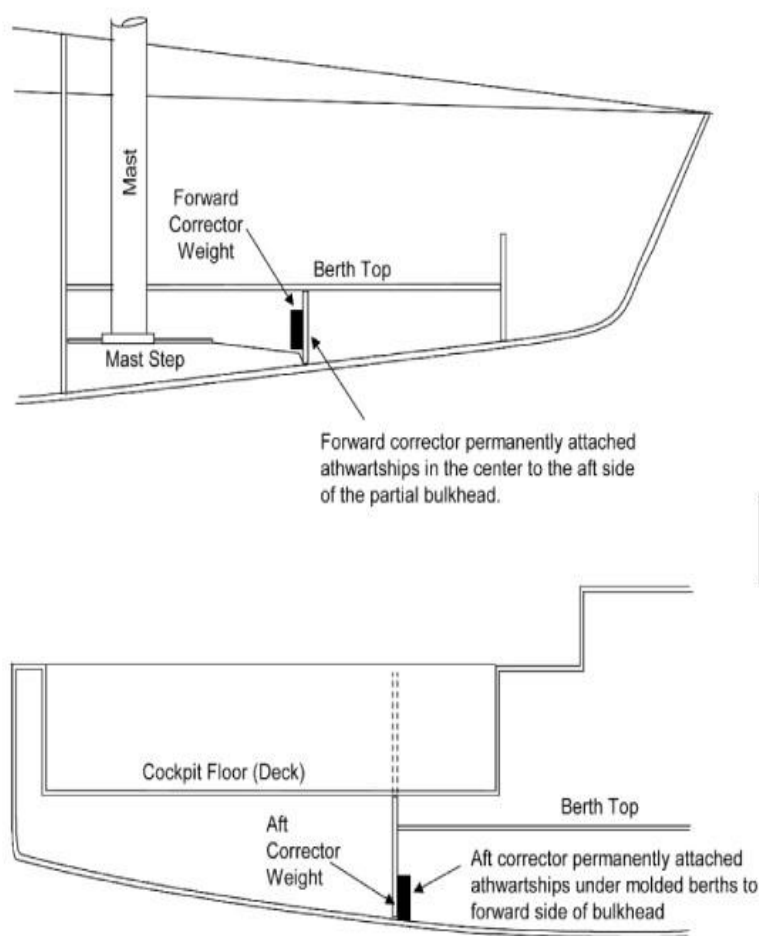

## Rule C.6.2

### J/24 Corrector Weight Axis of Orientation

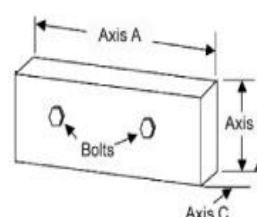

#### Notes:

- 1) Longest axis of lead corrector weight (Axis A) to be athwartships.
- 2) Second longest axis (axis B) to be oriented vertically.
- 3) Shortest axis to be oriented fore and aft.

- (b) Half the required **corrector weights** shall be fastened amidships on the forward half bulkhead, located approximately 1,000mm forward of the main bulkhead. Two quarters of the required **corrector weight**, in approximately equal ingots, shall be attached under each quarter berth to the forward side of the aft cabin bulkhead, located approximately 2,450mm aft of the main bulkhead.
- (c) The **corrector weights** shall be permanently fastened with bolts through the required bulkheads and sealed with a strap of fibre glass cloth. When required in addition to the permanent builder's correctors (D.7.1), the lead ingots shall be divided into four approximately equal weights fixed on the outboard side of the builder's correctors. The total **corrector weight** required to comply with rule C.6.1 shall be recorded on Measurement Form Part D and on the Inventory of Required and Optional Equipment.

## C.7 HULL

### C.7.1 MODIFICATIONS MAINTENANCE AND REPAIR

The following are permitted without re-**certification** or approval of the **certification authority**. Unless otherwise stated, items mentioned in this rule may be obtained from any manufacturer or supplier:

## MODIFICATIONS

- (a) Installation of permitted equipment with fasteners as required into or through the hull. Holes for mounting this equipment through cored sections of the hull may be encapsulated by replacing the core in the immediate vicinity of the hole with solid resin with optional filler.
- (b) Backer plates of fiberglass, aluminium or stainless steel, within the following limits may be used to help distribute loads from mounted hardware: Fiberglass and aluminium plates shall be a maximum of 8mm thick. Stainless steel plates or washers shall be a maximum of 4mm thick. Backer plates may not exceed the smaller of 40,000 square mm or 5 times the area of the base of the equipment they are supporting. Backer plates for stanchion bases may incorporate a short leg from the underside of the **deck** to the inside of the **hull**.
- (c) Bow and stern navigational light fittings are optional.

## MAINTENANCE

- (d) Cleaning and **hull** surface work like light sanding, painting and polishing which do not change the shape of the **hull**.

## REPAIRS

- (e) Minor repairs to the surface of the hull that do not change the shape nor penetrate into the core material. **Repairs** to hull, deck, keel and rudder may be done with any resin. Repairs shall utilize standard E-glass.
- (f) The filling or repair of old holes for previously installed equipment that may completely penetrate the hull.

### C.7.2 FITTINGS – MANDATORY

#### (a) FOR USE WHILE RACING.

- (1) Four **headsail** sheet tracks, each not more than 610mm in length and located as indicated in diagram below. Additional location holes may be drilled into these tracks for positioning the **headsail** cars.
- (2) Up to four **headsail** cars with turning blocks may be used at any time to trim the **headsails** (two cars on the same track is permitted). Turning block size is optional and blocks may ratchet; however, the vertical distance from the deck adjacent to the **headsail** track to the load bearing surface closest to the deck of the sheave of the turning block shall not be more than 110mm. **Headsail** cars may include integral cleats.
- (3) One **mainsail** traveller track, not exceeding 825mm in length, positioned as indicated in diagram below. The traveller track support bar may be of any material and shall not weigh less than 1kg.
- (4) Any two primary winches positioned on deck between the mainsheet traveller and the aft face of the forward end of the cockpit well and with a drum diameter not exceeding 80mm. Primary winches may be on pedestals.
- (5) The deck shall be fitted with two stanchions on each side, port and starboard, as indicated on Plan A. Taut (shall not sag more than 10mm between supports without any external loads) lifelines of wire, not less than 4mm diameter, shall be attached to the pulpit and pushpit and pass through the stanchions. The height of the lifelines above the **sheerline** when measured vertically shall not be less than 500mm. When the lifelines are secured by lanyards, the lanyards shall be of synthetic rope with an exposed length of not more than 100mm between the lifeline

fitting and the pulpit/pushpit fitting. The stanchions shall not extend outboard of the sheer in plan.

- (6) Pulpit and pushpit shall be supplied by a licensed builder or matched to an existing licensed design if required to be repaired or replaced. Pulpit and pushpit shall be located as shown in diagram below.
- (7) The vertical companionway hatch board shall originally be supplied by a licensed builder but may be replaced by one of the same design and material from any source.
- (8) Open cleats or "U" bolts may be interchanged for the three deck cleats in diagram below.
- (9) A minimum of one fixed (if the mount for the device is fixed to the **mast** or **hull**, it satisfies this requirement) device to deliver either a magnetic compass heading or course over the ground. This device shall not include charting capability.

# DECK LAYOUT

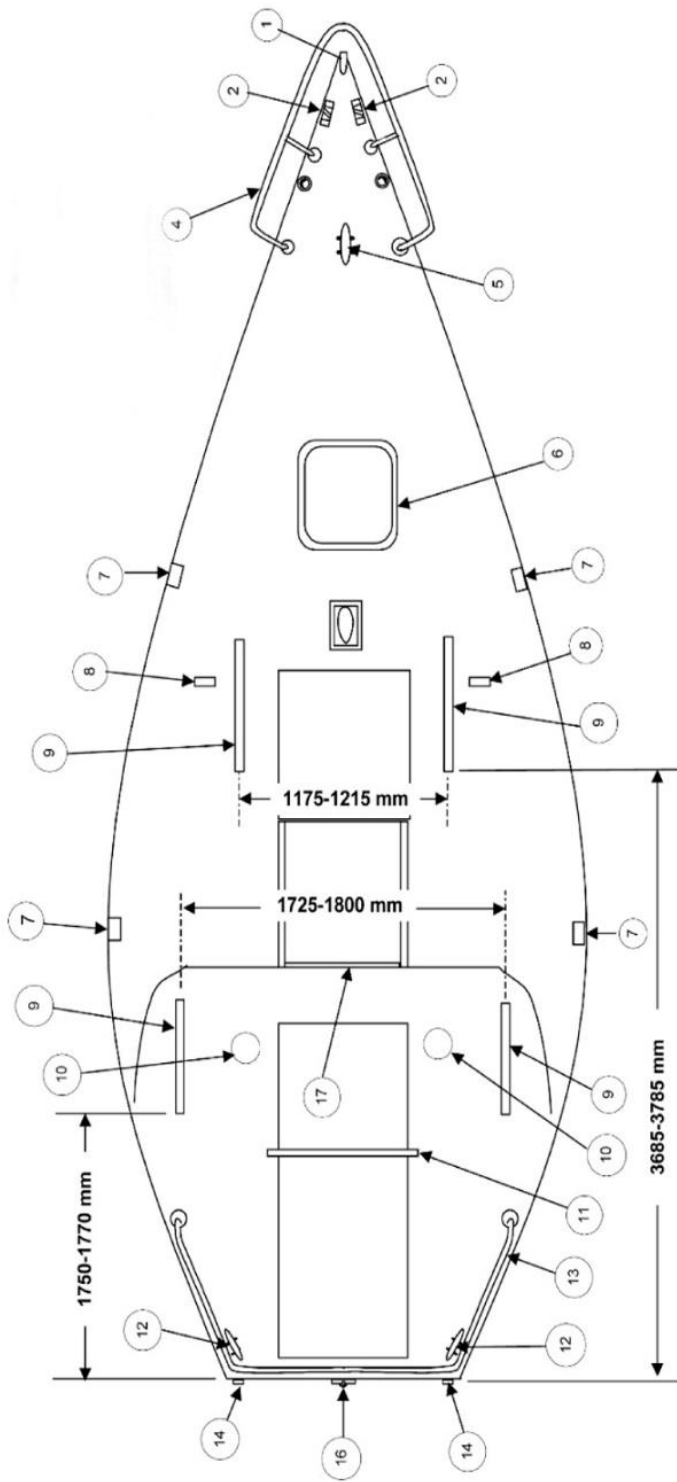

NO.	DESCRIPTION	NO.	DESCRIPTION	NO.	DESCRIPTION
1)	Stemhead Fitting	7)	Lifeline Stanchion and Base	13)	Stern Pulpit
2)	Chock	8)	Chainplate	14)	Transom Chainplate
3)	Navigation lights (optional)	9)	Jib/Genoa Track	15)	Not in use
4)	Bow Pulpit	10)	Primary Winch	16)	Upper and Lower Gudgeons
5)	Bow Cleat/Ring	11)	Traveler Bar	17)	Vertical Hatch Board
6)	Forward Hatch	12)	Stern Cleat		

(b) NOT FOR USE WHILE RACING.

(1) A complete outboard motor bracket fixed to the transom

### C.7.3 FITTINGS – OPTIONAL

#### (a) FOR USE WHILE RACING.

- (1) Any number of holders for drinks, winches handles, rope tails etc optional use and location
- (2) Any mechanical non electronic wind indicator may be positioned in the masthead, **sail** and/or **rigging**
- (3) Any Two secondary winches with a drum diameter not exceeding 74mm.
- (4) Electronic devices for tactical and navigational functions, excluding wind instruments.
- (5) Any fixed VHF radio and antenna.
- (6) One fixed platform to support the mainsheet cleating system attached either fore or aft to the centre of the mainsheet traveller bar.
- (7) Any foot rests/blocks may be attached to the mainsheet traveller bar, anywhere on the cockpit sole, cockpit decks and/or foredeck-
- (8) Lights for navigation, illuminating the deck or indicating **boat** at anchor may be installed on the mast and/or **spreaders**.
- (9) Watertight inspection ports may be fitted as necessary to facilitate use of the lifting rig, and to allow access to fittings and sealed spaces. Ports shall be closed when racing.
- (10) Anti-abrasion strips (rub strakes) may be applied to the aft edge of the upper deck in the path of the jib sheets as they run from the blocks on the forward **headsail** tracks to the blocks on the aft **headsail** tracks.
- (11) Elastic (shock) cord may only be used for the following purposes:
  - To hold down **sails**
  - To retain the throwable lifesaving device in the ready position in the cockpit,
  - To return the **backstay** adjuster toward the un-tensioned position,
  - Across the back of the pushpit to keep the slack backstay from falling into the cockpit area
  - As a single length wrapped around the mast and/or across the cabin top behind the mast for the purpose of retaining rope tails.
- (12) Nonslip materials may be added to the deck, cockpit, forward hatch and footrests.
- (13) Wire or rope transport guides for a below decks spinnaker bag as described in portable optional equipment.
- (14) Protective covers may be used on any part of the **rigging**.
- (15) Built in music/entertainment system and antenna if required. System shall not weigh more than 3kg and must be able to be removed for weighing

#### (b) NOT FOR USE WHILE RACING.

- (1) A mechanical (non-hydraulic) device to adjust the position of the mast heel on the mast beam.

## C.8 HULL APPENDAGES

The following are permitted without re-**certification** or approval of the **certification authority**.

### C.8.1 KEEL MODIFICATIONS, MAINTENANCE AND REPAIR.

#### MODIFICATION

(a) The shape of the **keel** shall not be modified.

#### MAINTENANCE

(b) Routine maintenance such as cleaning and polishing is permitted without re-measurement and re-**certification**.

#### REPAIR

(c) Small repairs may be made to the **keel** without re-measurement and re-**certification** as long as they do not change the shape.

### C.8.2 RUDDER MODIFICATIONS, MAINTENANCE, REPAIR and INSTALLATION

#### MODIFICATION

(a) The shape of the rudder shall not be modified.

#### MAINTENANCE

(b) Routine maintenance such as cleaning and polishing is permitted without re-measurement and re-**certification**.

#### REPAIR

(c) Small repairs may be made to the **Rudder** without re-measurement and re-certifications long as they do not change the shape and the repairs are made with fibreglass and fairing resins. Pins and gudgeons may be replaced with ones from the same manufacturer in the same holes on the **rudder** or transom without re-measurement and re-**certification**.

#### INSTALLATION

(d) The rudder shall be installed in compliance with Plan D

## C.9 RIG

### C.9.1 MODIFICATIONS, MAINTENANCE AND REPAIR

The following are permitted without re-**certification** or approval of the **certification authority**. Unless otherwise stated, items mentioned in this rule may be obtained from any manufacturer or supplier

#### MODIFICATIONS

(a) No alterations or modifications to the **spar** extrusions are permitted except to facilitate the attachment of **rigging** and fittings, including relocation of exit slots, as specified in these rules.

(b) Any cleats with or without associated fairleads may be attached to the **mast** to stop halyards and control lines.

(c) Unused fittings may be removed from the **mast** and **boom spars**, and tape or sealants may be used to cover holes and around fittings

#### MAINTENANCE

(d) Routine maintenance such as cleaning and polishing is permitted.

(e) Sheaves and the pins on which they turn may be replaced by ones of similar size. Sheaves with bushings or ball bearings are permitted



## REPAIR

- (f) Fittings may be replaced as needed with similar fittings and limit marks may be replaced in exactly the same location without re-measurement and re-certification.

### C.9.2 FITTINGS

- (a) Not more than two **spinnaker pole** attachment fittings shall be fixed to the forward surface of the mast in accordance with F.3

### C.9.3 LIMITATIONS

- (a) Only one set of **spars** and **standing rigging** shall be used during an event, except when an item has been lost or damaged beyond repair, and the race committee has approved the substitution.

### C.9.4 MAST

The **mast spar** shall be supplied by a licensed manufacturer.

#### (a) DIMENSIONS

	minimum	maximum
<b>Mast datum point</b> above the <b>sheerline</b> at the forward face of the <b>mast</b> . Shims under the <b>mast</b> may be used to attain this height.	400mm	
<b>Mast datum point</b> to intersection of the stemline and the <b>sheerline</b>	2895mm	2925mm
<b>Lower point height (lower limit mark above the mast datum point)</b>	635mm	670mm
<b>Upper limit mark above the lower limit mark</b>		8538mm
<b>Limit mark width</b>	19mm	
Center of <b>forestay</b> fixing point projected from the forward face of the <b>mast</b>	20mm	30mm
<b>Spreader Length</b>	760mm	800mm

#### (b) LIMITATIONS

- (1) The mast **spar** shall be fixed at the heel by screws or pins to the mast beam and shall be securely chocked at the deck level by any manner of shims in the partners and/or a plate fixed on top of the deck. The position of the mast **spar** at the heel and the deck shall not be altered while racing.

### C.9.5 BOOM

The **boom spar** shall be supplied by a licensed manufacturer

#### (a) DIMENSIONS

	minimum	maximum
<b>Limit mark width</b>	19 mm	
<b>Outer point distance (mast to limit mark)</b>		2970mm

### C.9.6 SPINNAKER POLE

#### (a) LIMITATIONS

- (1) The **spinnaker pole** may be rigged with a bridle or other fittings to which control lines may be attached.

- (2) The **spinnaker pole** may be rigged with a trip line(s) to the required pole ends.

#### C.9.7 STANDING RIGGING

##### (a) DIMENSIONS

	minimum	maximum
<b>Forestay</b> length measured from between the centre of the <b>forestay</b> fixing point on the jib crane at the hounds and the intersection of the stemline at the <b>sheerline</b> (see diagram in G.3.1(a))		8670 mm

##### (b) OPTIONAL

- (1) **Rigging** links, **rigging** screws and turnbuckles of various types may be used to adjust the length of the **rigging**.
- (2) Locking devices of optional design may be used to facilitate **rigging** adjustment and locking.

##### (c) LIMITATIONS

- (1) **Rigging** links and **rigging** screws (turnbuckles) shall not be adjusted while racing.
- (2) No over the center lever devices shall be used to adjust length of **rigging**.
- (3) The **forestay** length shall not be adjusted at any time for the duration of an event.

#### C.9.8 RUNNING RIGGING

##### (a) FOR USE WHILE RACING - MANDATORY

- (1) The **mainsail sheet** shall be led to the traveller car and/or a stationary block at the centre of the traveller bar with purchase of not more than 6:1.
- (2) The **mainsail sheet** traveller control shall have no more than 2:1 purchase. Location of turning blocks and cleats is optional.
- (3) The **mainsail outhaul** shall be internal in the **boom spar** and shall not exceed 6:1 purchase.
- (4) The kicking strap (vang) shall be led from a fitting on the **mast spar** to a fitting on the **boom spar** and shall not exceed purchase of 8:1.
- (5) The **mainsail** Cunningham control shall be led from a cringle on the luff of the mainsail to a fitting below it on the **mast spar**. Purchase shall not exceed 6:1.
- (6) The **mainsail halyard** shall enter the sheave at the top of the back of the **mast** and run down through an exit slot or exit block above the deck to optional termination. Purchase shall be 1:1. **Halyard** locks aloft are not allowed.
- (7) The **headsail halyard** shall enter the mast through the jib crane below the **forestay** fixing point and run down through an exit slot or exit block above the deck to optional termination. Purchase shall be 1:1. **Halyard** locks aloft are not allowed.
- (8) The **headsail sheet** shall be led to a turning block on a **headsail** car. Purchase shall be 1:1.

- (9) The **spinnaker sheet** and **spinnaker guy** shall be led first to turning blocks attached to the base of the forward leg of the pushpit, then through turning blocks in optional locations. Purchase shall be 1:1.
- (10) The **spinnaker pole** topping lift shall enter the **mast** through a block that has been located by the licensed builder on the front of the **mast** between the jib crane and the spreaders, then exit the **mast** above the deck to further turning blocks and cleats as desired. Purchase shall be 1:1.
- (11) The **backstay** adjuster shall run from the bridle block on the **backstay** through fairleads on the inside of the transom and then through any arrangement of turning blocks and cleats as desired. Purchase shall not exceed 4:1.

(b) FOR USE WHILE RACING - OPTIONAL

- (1) If a **headsail** Cunningham is used it shall not exceed 6:1 purchase and may be led and cleated as desired.
- (2) Reefing lines systems with layout and purchase optional.
- (3) **Spinnaker pole** down-haul at 1:1 purchase.
- (4) **Headsail** sheet barber haulers of synthetic rope, one on the port side and one on starboard, may be attached to the jib or genoa **sheets** between the **clew** of the **sail** and the track mounted **sheet** fairlead for the purpose of shifting the lead outboard only. They shall consist of a single part of rope (1:1 power ratio) with a ring, block or hook to engage the **sheet** and led through a turning block to a cleat. Location of the turning block(s) and cleat is optional. This system is allowed at both the forward and aft **headsail** tracks.
- (5) Spinnaker **sheet** barber haulers (twings) of synthetic rope, one in the port side and one on starboard, each consisting of one or two fairleads or blocks and one cleat. Location is optional. The Barber haulers may be attached to the **spinnaker sheet/guy** by a block, hook or ring. Purchase shall be 1:1.
- (6) To double the purchase of the **sheet** of the 100% jib, the **sheet** may be lead through the **clew** cringles and back to the base of the turning block on the traveller car.
- (7) A topping lift for the main **boom** at 1:1 purchase.

(c) FOR USE WHILE RACING – LIMITATIONS

Running rigging shall not be rigged below deck.

## C.10 SAILS

### C.10.1 MODIFICATIONS, MAINTENANCE AND REPAIR

The following is permitted without re-**certification** or approval unless otherwise specified.

#### MODIFICATIONS

- (a) Draft stripes (camber stripes) may be added.

#### MAINTENANCE

- (b) Routine maintenance such as cleaning and the removal and replacement of battens in **batten pockets**.

#### REPAIR

- (c) Repair of minor damage such as **sail** tape patches over tears may be done.

#### C.10.2 LIMITATIONS

- (a) Not more than one **mainsail**, one jib, one genoa and one spinnaker shall be carried aboard. This class rule may be amended by the sailing instructions.
- (b) Not more than one **mainsail**, one jib, one genoa, and one spinnaker shall be used during an event of less than eight consecutive days (including any lay days), except when a **sail** has been lost or damaged beyond repair. This class rule may be amended in the-sailing instructions.

#### C.10.3 IDENTIFICATION

- (a) National letters and distinguishing numbers may be replaced to match a new owner's requirements without re-**certification**, if the sails are sold.
- (b) Class insignia, national letters and distinguishing numbers shall be placed on the **mainsail**, genoa and spinnaker in accordance with Appendix G of the *Racing Rules of Sailing* except that the last digit of the starboard number and the first digit of the port number shall be within 200mm of the genoa **luff** and the last digit of the port number and the first digit of the starboard number shall be within 200mm of the **mainsail leech**.

#### C.10.4 MAINSAIL

##### (a) LIMITATIONS

- (1) The **sail** shall be hoisted on a **halyard**. The arrangement shall permit hoisting and lowering of the **sail** while afloat.
- (2) **Luff** and **foot** bolt ropes shall be in the **spar** grooves or tracks.
- (3) The **tack** of the **mainsail** may float or be fixed.
- (4) The **clew** shall be attached to the **outhaul**.

#### C.10.5 HEADSAIL

##### (a) LIMITATIONS

- (1) The **sail** shall be hoisted on a **halyard**. The arrangement shall permit hoisting and lowering of the sail while afloat.
- (2) The **tack** of the **headsail** may float or be fixed.
- (3) The **clew** shall be attached to the **headsail** sheets.
- (4) A tacking line may be attached to the **foot** of the genoa.

#### C.10.6 SPINNAKER

##### (a) LIMITATIONS

- (1) The spinnaker shall be hoisted on a **halyard**. The arrangement shall permit hoisting and lowering of the **sail** while afloat.
- (2) The spinnaker may be stowed in and launched from the companionway from a bag of optional design.

## Section D – Hull

### D.1 PARTS

#### D.1.1 MANDATORY

- (a) **Hull**/deck shell.
- (b) Bulkheads.
- (c) Toe rails.
- (d) Bunk boards.
- (e) Interior **hull** liner with **keel** access board.
- (f) Interior mouldings and cabinets.
- (g) Vertical companionway hatch board.
- (h) **Keel** stub (sump).
- (i) **Mast** step beam.
- (j) V-Berth

#### D.1.2 OPTIONAL

- (a) Buoyancy compartments.
- (b) Basin and/or a sink and/or a stove.
- (c) Navigation table.

### D.2 GENERAL

#### D.2.1 RULES

The **hull** shall comply with the current **class rules** unless stated otherwise

#### D.2.2 MODIFICATIONS MAINTENANCE AND REPAIR

The following will require re-measurement and re-**certification** and may be done by anyone, unless otherwise noted.

##### MODIFICATIONS

- (a) Interiors may be modified or rebuilt to conform to any of the three interior layouts shown in diagram below. Individual features of these layouts may be mixed in a single interior. Such modifications shall be executed in fiberglass and/or plywood in a manner as similar as possible in weight and dimensions to what is provided in new work from licensed builders. Such work shall not change the dry weight of the **boat** by more than 5kg. Bunk boards shall be plywood between 9mm and 13mm thick. Plywood replacements for the V-berth and cabin soles shall be between 9mm and 13mm thick. Fiberglass may also be used for the V-berth and with balsa core for the cabin sole to builder specifications.

## INTERIOR LAYOUT I

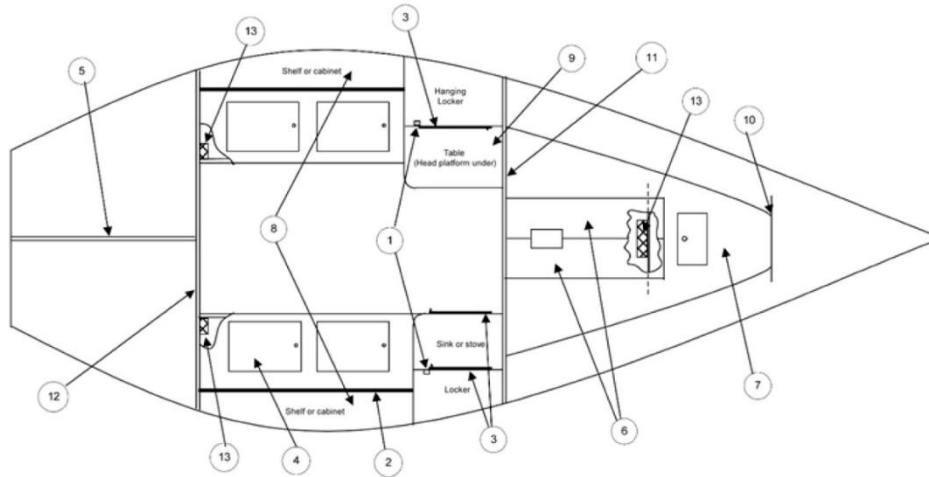

No.	DESCRIPTION	MATERIAL	No.	DESCRIPTION	MATERIAL
1	Door Latch Mounts, P&S	Teak	8	Shelf, P&S	Marine Plywood
2	Shelf/Cabinet Riser, P&S	Teak	9	Chart Table	Marine Plywood
3	Teak Door with Handle	Teak Frame	10	Forward Bulkhead	Marine Plywood
4	Berth Access Covers, P&S	Marine Plywood	11	Main Bulkhead	Marine Plywood
5	Cockpit Support	Marine Plywood	12	Aft Bulkhead	Marine Plywood
6	V-Berth Access Covers	Marine Plywood	13	Corrector Weight	Lead
7	V-Berth, Fixed Portion	Marine Plywood			

## INTERIOR LAYOUT II

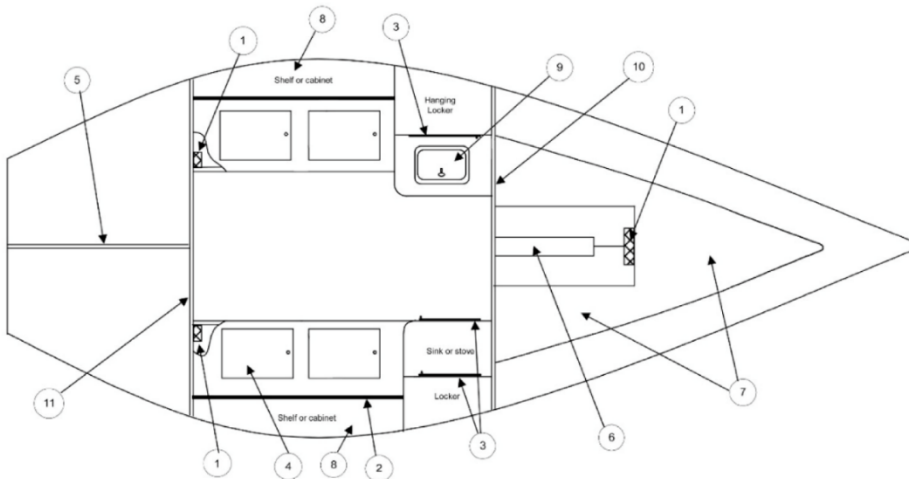

No.	DESCRIPTION	MATERIAL	No.	DESCRIPTION	MATERIAL
1	Corrector Weight	Lead	7	Forward Floatation Tank	Fiberglass/Plywood
2	Shelf/Cabinet Riser	Fiberglass/Plywood	8	Shelf P & S	Fiberglass/Plywood
3	Access Hatches	Plastic	9	Battery Access Hatch	Plastic
4	Berth Boards	Plywood	10	Main Bulkhead	Plywood
5	Cockpit Support	Plywood	11	Aft Bulkhead	Plywood
6	Mast Bearing Beam	Aluminum			

## INTERIOR LAYOUT III

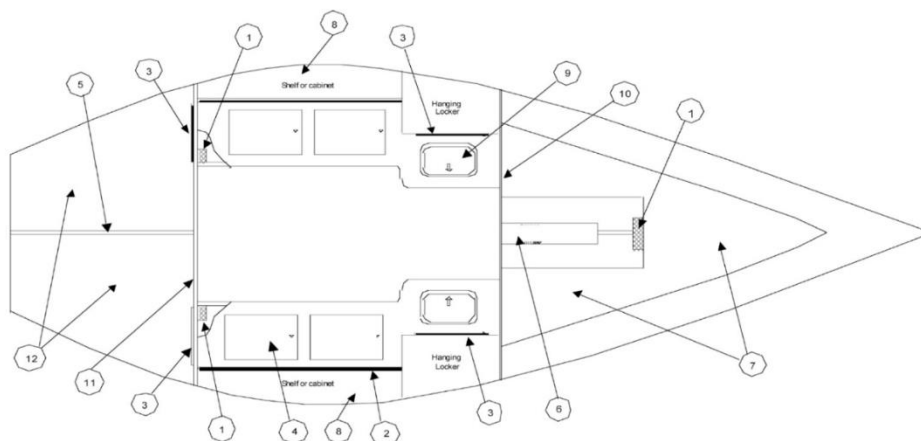

No.	DESCRIPTION	MATERIAL	No.	DESCRIPTION	MATERIAL
1	Corrector Weight	Lead	7	Forward Floatation Tank	Fiberglass/Plywood
2	Shelf/Cabinet Riser	Fiberglass/Plywood	8	Shelf P & S	Fiberglass/Plywood
3	Access Hatches	Plastic	9	Battery Access Hatch	Plastic
4	Berth Boards	Plywood	10	Main Bulkhead	Plywood
5	Cockpit Support	Plywood	11	Aft Bulkhead	Plywood
6	Mast Bearing Beam	Aluminum	12	Aft Flotation Tanks	Fiberglass/Plywood

- (b) Holes not bigger than necessary for the installation of fittings and passage of lines (control lines may not pass through the deck) may be made in the deck and interior hull liner. These holes may be resin encapsulated to protect the core from moisture and crush.
- (c) Plywood bunk boards on the quarter berths may be modified with hinges, latches, holes or extensions to accommodate the storage of motors and equipment. If the bunk boards are able to be securely latched to the **hull** liner, items contained beneath them may be considered secured against movement in the event of capsizing.
- (d) The keel stub may be faired to adjust keel position, but not in such a way as to compromise structure or to effect a change in weight distribution. The width of the keel stub (before or after fairing) may not be less than 185mm at a point 19mm below the hull and 760mm (on the contour) forward of a point 30mm below the hull on the trailing edge.
- (e) Buoyancy compartments are sections of the boat below deck that have been sealed and use water resistant, sealed hatches or inspection ports for access. These compartments have been incorporated by the builders in newer models, and may also be copied by others in remodelling older boats. Such non-builder versions shall be very similar to those supplied by licensed builders. Hatches or inspection ports to these compartments must be sealed while *racing*.
- (f) If the shroud chainplates attached to the aft side of the main bulkhead are not symmetrical about the longitudinal centreplane, either one (one only) may be moved laterally on the main bulkhead so that they become symmetrical about the longitudinal centreplane.
- (g) Oversized backing plates, maximum 5mm in thickness, of aluminium up to 110,000 square mm, and of Stainless Steel up to 60,000 square mm, may be added to the forward side of the main bulkhead. Up to 5 additional bolts through the bulkhead and the backer plate may be added in order to better



spread the load to the bulkhead.

#### REPAIRS

- (h) All bulkheads and structural members shall only be repaired or replaced with materials as identical as possible to original. The exception to this is for **boats** produced prior to 1982 with vermiculite filled resin used to support the cabin sole and **keel** stub (sump) and the **keel** bolts. Such materials, if removed, shall be replaced by a support system and filler consistent with new construction. Instructions for this are available from the ICA. This exception and replacement shall also apply to any **boat** with vermiculite filled resin that was used to support the keel/lifting bolts in the aft section of the **keel** stub (sump).
- (i) The narrow separators between the bunk boards of the quarter berths that support those bunk boards are prone to breakage. When cracked or broken, they may be repaired and reinforced with fiberglass/wood/metal structures not exceeding 30mm in thickness including the original material.
- (j) Repairs of major holes from collisions or other impacts require permission and supervision of a class measurer and documentation of the process and materials used. Such supervision does not have to be on site. It may be done by photos and written documentation that is sent to the measurer. The primary qualification on this requirement is penetration of the repair into the core material. This would also include replacement of wet core. This does not include the filling of holes left by removal of fittings or equipment.

#### D.2.3 LIMITATIONS

- (a) Removal of gelcoat above or below the waterline for purposes of fairing the **hull** is not permitted. However, gelcoat may be abraded only as much as necessary to allow adhesion for paint or coatings. Such paint or coatings may then be faired.
- (b) No modifications shall be made if it changes the distribution of weight in the **boat**.
- (c) The exterior of the joint between the **hull** and the transom shall have no less than a 2mm radius.

#### D.2.4 DEFINITIONS

- (a) **HULL DATUM POINT** is where the transom or its extension meets the bottom of the **hull** shell or its extension on the **hull** centreplane.

#### D.2.5 IDENTIFICATION

- (a) The **hull** identification number shall be assigned by J Boats, Inc.
- (b) The **hull** identification number shall be moulded into the transom.

#### D.2.6 BUILDERS

- (a) The **hull** shall be built by a builder licensed by J Boats, Inc.
- (b) All moulds shall be approved by J Boats, Inc.
- (c) The ICA may assist with approval of the moulds.
- (d) No moulds shall be modified after approval by J Boats, Inc. without the written approval of J Boats, Inc.



### **D.3 HULL/DECK SHELL**

#### **D.3.1 MATERIALS**

The **hull**/deck shell shall be built from fiberglass reinforced resin over balsa core to specifications and layup schedules supplied by J Boats, Inc. to its licensed builders.

#### **D.3.2 CONSTRUCTION**

Construction of the **hull**/deck shell shall be by hand layup in the approved moulds to dimensions, specifications and plans as supplied by J Boats, Inc.

### **D.4 BULKHEADS**

#### **D.4.1 MATERIALS**

Bulkheads shall be constructed of marine grade plywood.

#### **D.4.2 CONSTRUCTION**

Construction of bulkheads shall be to designs supplied by J Boats. Bulkheads shall be tabbed to the **hull** shell according to the designs and layup schedules supplied by J Boats, Inc. to its licensed builders.

### **D.5 INTERIOR LINER**

#### **D.5.1 MATERIALS**

The interior liner shall be made of fiberglass reinforced resin.

#### **D.5.2 CONSTRUCTION**

The interior liner shall be constructed by a licensed builder as described by the J/24 Interior Liner Detail and be bedded to the aft side of the main bulkhead and to the **hull**/deck shell as specified by J Boats, Inc. to its licensed builders.

### **D.6 ASSEMBLED HULL**

#### **D.6.1 FITTINGS**

##### **(a) MANDATORY**

The following fittings shall be positioned in accordance with C.7.2(a) DECK LAYOUT diagram of these **class rules**:

- (1) One stemhead fitting.
- (2) Two Chocks.
- (3) One bow pulpit.
- (4) One bow cleat/ring.
- (5) One forward hatch.
- (6) Four lifeline stanchions and bases.
- (7) Four chainplates.
- (8) Four **headsail** tracks.
- (9) Two primary winches.
- (10) One mainsheet track with traveller bar.
- (11) Two stern cleats/rings.
- (12) One stern pushpit.
- (13) Two upper and lower rudder gudgeons.
- (14) One vertical companionway hatch board

## D.7 WEIGHTS

### D.7.1 BUILDER WEIGHT (ASSEMBLED HULL)

- The weight of the **hull** including **keel**, **rudder** and tiller with all of the **hull's** specified mouldings, structures and fixed fittings as detailed in C.7.2(a) DECK LAYOUT diagram, shall not be less than 1190 kg, nor more than 1250 kg.
- The Licensed Builder shall weigh the **hull** as described in (a) above and record the weight in the appropriate place on Measurement Form Part B.
- Builder's **corrector weights**, if required, shall be lead ingots installed in the same way as described in C.6.2(b), and permanently attached with bolts, fully encapsulated and marked with a distinctive mark to distinguish them from other **corrector weights**. Builder's corrector weights shall not be removed or altered.

## D.8 KEEL STUB

### D.8.1 DIMENSIONS

- The distance between the **hull datum point** and the intersection of the trailing edge of the **keel stub** and the **hull shell**, each extended as necessary, shall be no more than 3020mm nor less than 2996mm measured on the centreplane along the **hull** contour.
- At the intersection of the trailing edge of the **keel stub** and the **hull shell**, each extended as necessary, the thickness of the **keel stub** shall be no less than 22mm wide.
- Where the trailing edge of the **keel stub** meets the trailing edge of the **keel** at 153mm below the **hull shell** (also known as section I on diagram below), neither the trailing edge of the **keel stub** nor the trailing edge of the **keel** shall be less than 12.8mm wide.

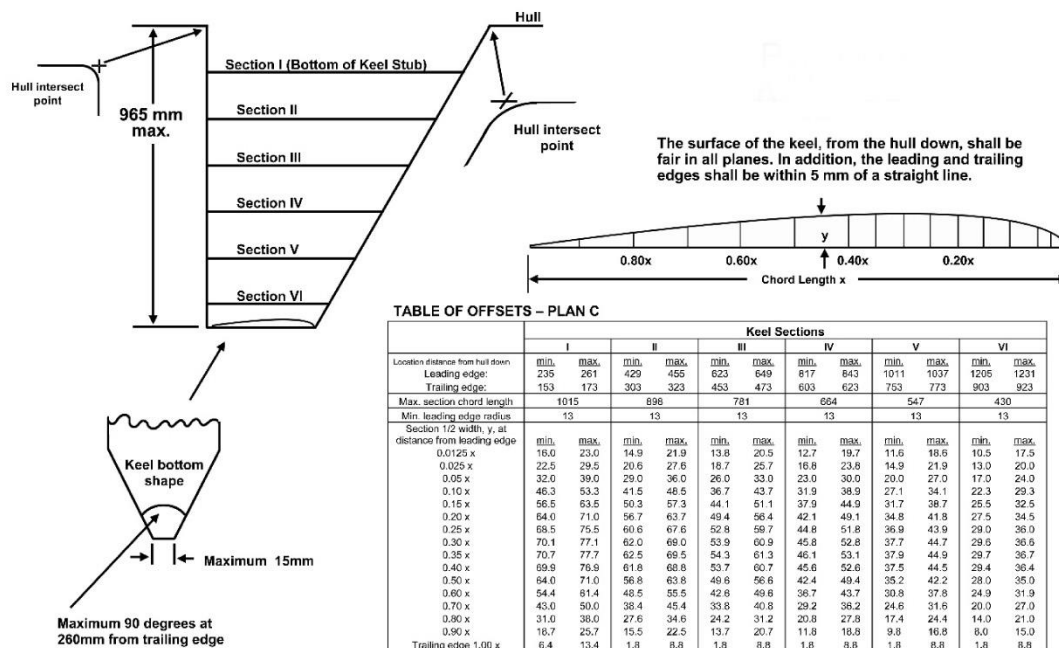

# Section E – Hull Appendages

## E.1 PARTS

### E.1.1 MANDATORY

- (a) **Keel**
- (b) **Rudder**

## E.2 GENERAL

### E.2.1 RULES

- (a) **Hull appendages** shall comply with these class rules

### E.2.2 MODIFICATIONS, MAINTENANCE AND REPAIR

The following will require re-measurement and re-**certification** and may be done by anyone, unless otherwise noted.

#### MODIFICATIONS

- (a) **Hull appendages** may be faired and shaped by adding or removing material as long as it continues to comply with the dimensions and offsets in D.8.1(c) diagram for **keels** and in diagram below for **rudders**.

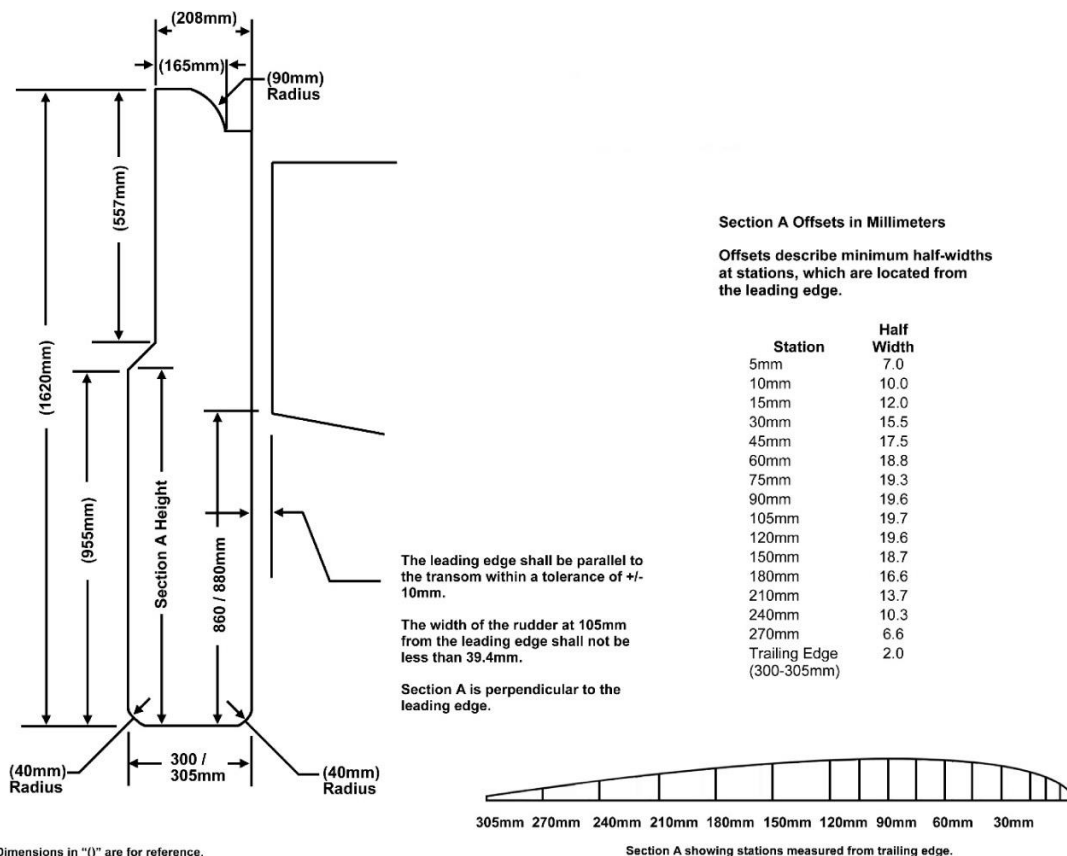

Dimensions in "( )" are for reference.

- (b) Fairing materials used on **hull appendages** may not exceed the density of standard fiberglass construction. No metals or heavy fillers may be added to the fairing resin.

#### REPAIR

- (c) **Keels** shall only be removed and reset or replaced by a licensed builder.

### E.2.3 MANUFACTURERS

- (a) The **hull appendages** shall be made by builders licensed by J Boats, Inc.

## E.3 KEEL

### E.3.1 MATERIALS

- (a) The **keel** shall be made of lead or lead alloy to the specifications supplied to licensed builders by J Boats, Inc.
- (b) The lead **keel** shall be covered with fiberglass reinforced resin or filled resin to the dimensions specified in these class rules in D.8.1(c). It may also be gel coated or painted.

### E.3.2 CONSTRUCTION

- (a) The **keel** shall be manufactured in a mould approved by J Boats, Inc. World Sailing and the ICA may assist in the approval of moulds.
- (b) The **keel** shall be attached to the **hull** with 5 stainless steel **keel** bolts to J Boats' specifications.
- (c) The aft two **keel** bolts shall have a stainless steel bar or eye fixed between them for lifting the **boat**.

### E.3.3 DIMENSIONS

- (a) The **keel** shall comply with all of the dimensions of diagram in D.8.1(c). For purposes of compliance measurement, the sections on Plan C Table of Offsets may be lowered up to 20mm.
- (b) The distance from the **hull datum point** to the trailing edge of the **keel** 603mm below the **hull** shell shall be not more than 3125mm, nor less than 3095mm.
- (c) The surface of the **keel** from the **hull** shell down, including the **keel** stub, shall be fair in all planes.
- (d) The leading and trailing edges of the **keel** shall be within 5mm of a straight line between sections I and VI.
- (e) The trailing edge of the **keel** shall not be less than 3.6mm wide below section I.

### E.3.4 WEIGHTS

- (a) The **keel** weight shall be not more than 435kg or less than 415kg before it is attached to the **keel** stub and faired to the boat.
- (b) The actual **keel** weight shall be recorded in section B of the measurement form by the licensed builder.

## E.4 RUDDER BLADE AND TILLER

### E.4.1 MATERIALS

- (a) The **rudder** blade shall be made of fiberglass reinforced resin over a balsa core.
- (b) The tiller shall be made of wood. The wood may be laminated with glue.

### E.4.2 CONSTRUCTION

- (a) The **rudder** blade shall be made by a builder licensed by J Boats, Inc. to comply with **class rules** including Plan D.

(b) The tiller builder is optional.

#### E.4.3 FITTINGS

##### (a) MANDATORY

- (1) Gudgeons and pintles and/or pins which may be replaced with similar or heavier fittings from any manufacturer as long as those fittings do not project the **rudder** any more than 50mm from the transom to the leading edge of the **rudder**.

#### E.4.4 WEIGHTS

- (a) The weight of the **rudder**, with attached pintles or gudgeons, shall not be less than 11.2kg.
- (b) **Corrector weights** may be added to the aft edge of the **rudder** head, above the waterline. The **corrector weights** shall be exposed to view and strapped to the rudder head with fiberglass and resin.

# Section F – Rig

## F.1 PARTS

### F.1.1 MANDATORY

- (a) **Mast Spar**
- (b) **Boom Spar**
- (c) Standing **rigging**
- (d) Running **rigging**
- (e) **Spinnaker Pole**

## F.2 GENERAL

### F.2.1 RULES

- (a) The **spars, rigging** and their fittings shall comply with the **class rules**.

### F.2.2 MODIFICATIONS, MAINTENANCE AND REPAIR

- (a) **Spars** shall not be altered in any way except as permitted by these **class rules**.
- (b) The **mast spar** may be cut off at the bottom to comply with the minimum height of the **mast datum point** above the **sheerline**.
- (c) Sleeves may be used to repair **spars** and/or to cover holes from missing fittings.

## F.3 MAST

### F.3.1 MATERIALS & CONSTRUCTION

- (a) The **mast** extrusion shall include a fixed **sail** groove, integral with the **spar**.

### F.3.2 DEFINITIONS

- (a) The **mast datum point** shall be located and permanently marked by a class measurer on the forward face of the **mast** at 7725mm below the centre of the pin that attaches the forestay to the jib crane of the **mast**.
- (b) The **mast datum point** shall be distinguished by a contrasting coloured band of 19mm to 26mm in width, around the **mast**, the lower edge of which shall match the permanent mark of the **mast datum point**.

### F.3.3 FITTINGS

- (a) MANDATORY
  - (1) Top Plate.
  - (2) **Mast** head fitting (crane).
  - (3) **Mainsail halyard** sheave.
  - (4) Two upper **shroud** gibs.
  - (5) **Forestay/jib** crane.
  - (6) Two spinnaker **halyard** sheaves.
  - (7) **Headsail halyard** sheave.
  - (8) **Spinnaker pole** lift exit block.
  - (9) **Spreader** compression tube and brackets or **spreader** bar.
  - (10) A pair of **spreaders**.
  - (11) Two lower **shroud** gibs.

- (12) A maximum of two **spinnaker pole** fittings.
- (13) Gooseneck.
- (14) Kicking strap **attachment**.
- (15) Cast heel fitting.
- (16) **Mast** Step.

(b) OPTIONAL

- (1) One mechanical wind indicator
- (2) Compass bracket
- (3) **Mainsail halyard** exit sheave box
- (4) **Headsail halyard** exit sheave box
- (5) Spinnaker **halyard** exit sheave box
- (6) Fittings for main Cunningham
- (7) Steaming lights and anchor lights

F.3.4 DIMENSIONS

- (a) All **mast spar** dimensions shall comply with the drawings and specifications supplied to licensed builders by J Boats, Inc.

F.3.5 LIMITATIONS

- (a) The **spinnaker pole fitting height** shall not exceed 1555mm.
- (b) The **spinnaker pole fitting projection** shall not exceed 55mm.

**F.4 BOOM**

F.4.1 MATERIALS & CONSTRUCTION

- (a) The **boom spar** extrusion shall include a fixed **sail** groove, integral with the **spar**.
- (b) The **boom spar** shall be made of aluminium by a licensed builder to the plans and specifications supplied by J Boats, Inc.

F.4.2 FITTINGS

(a) MANDATORY

- (1) Cast aluminium gooseneck **attachment** fitting (older gooseneck fittings may have the parts for a fixed tack and reefing horns removed).
- (2) Kicking strap (vang) fitting

(b) OPTIONAL

- (1) Fittings to facilitate reefing.
- (2) Attachment for a **boom** topping lift to the **boom** end fitting.

F.4.3 WEIGHT

The tip weight of a **boom** measured at the outer point of the **outhaul**, when the **spar** is supported at the gooseneck without a vang, mainsheet and blocks, shall not be less than 3.3kg.

**F.5 SPINNAKER POLE**

F.5.1 BUILDER

- (a) Builder is optional.

## F.5.2 MATERIALS

- (a) The **spar** may be of aluminium or carbon fibre reinforced resin.
- (b) **Spinnaker pole** ends material is optional.

## F.5.3 FITTINGS

- (a) **Spinnaker pole** end fittings (2) are required.
- (b) Fittings other than the pole ends are optional.

## F.5.4 DIMENSIONS

- (a) **Spinnaker pole length** (including ends) shall be no more than 2895mm.

## F.6 STANDING RIGGING

### F.6.1 MATERIALS

- (a) The **shrouds** and **forestay** shall be of stainless steel multi-strand wire.
- (b) The **backstay** and **backstay** bridle shall be of stainless steel multi-strand wire.

### F.6.2 CONSTRUCTION

- (a) Builder/supplier is optional
- (b) MANDATORY
  - (1) A **forestay** of minimum 4.7mm.
  - (2) Upper **shrouds** (2) of minimum 4.7mm
  - (3) Lower **shrouds** (2) of minimum 4.7mm
  - (4) **Backstay** and **backstay** bridle of minimum 3.9mm

### F.6.3 FITTINGS

- (a) MANDATORY
  - (1) **Shroud rigging** screws (turnbuckles) (4)
- (b) OPTIONAL
  - (1) **Forestay rigging** links and/or **rigging** screw (turnbuckle)
  - (2) **Backstay** bridle **rigging** screws (turnbuckles)
  - (3) **Shroud rigging** links

### F.6.4 DIMENSIONS (See C.9.7(a))

- (a) **Standing rigging** shall comply with **class rules**.

## F.7 RUNNING RIGGING

### F.7.1 PARTS/MATERIALS – Builder/supplier is optional

- (a) MANDATORY
  - (1) **Mainsail halyard** – wire and/or synthetic rope.
  - (2) **Mainsail sheet** – synthetic rope.
  - (3) Kicking strap (vang) – synthetic rope with an optional strop of wire or synthetic rope to attach the block to the mast bracket.
  - (4) **Headsail halyard** – wire and/or synthetic rope.
  - (5) **Headsail sheets** – synthetic rope.
  - (6) **Spinnaker halyard** – synthetic rope.
  - (7) Spinnaker **sheet** and **Spinnaker guy** – synthetic rope.
  - (8) **Spinnaker pole** lift or up-haul – synthetic rope.



- (9) **Mainsail** traveller control – synthetic rope.
  - (10) **Backstay** adjuster – synthetic rope
  - (11) **Mainsail** Cunningham – wire and/or synthetic rope.
  - (12) **Mainsail outhaul** – wire and/or synthetic rope.
- (b) OPTIONAL
- (1) **Headsail** Cunningham line – wire and/or synthetic rope
  - (2) **Headsail** Barber haulers – synthetic rope
  - (3) **Spinnaker** Barber haulers (twings) – synthetic rope
  - (4) **Spinnaker pole** downhaul – synthetic rope
  - (5) Main **Boom** topping lift – wire or synthetic rope
  - (6) Reefing lines – synthetic rope

## Section G – Sails

### G.1 PARTS

#### G.1.1 MANDATORY

- (a) **Mainsail**
- (b) Genoa
- (c) Jib
- (d) Spinnaker

### G.2 GENERAL

#### G.2.1 CONSTRUCTION

- (a) The **body of the sail** shall be single-**ply sail**. For the **mainsail** and jib, the **ply** material shall be of woven polyester. For the genoa, the **ply** material shall be either woven and/or laminated **ply** of polyester, HMPE or aramid. For the spinnaker, the **ply** material shall be woven nylon. Elastic material is only allowed in **batten pockets**.
- (b) The **mainsail**, jib and genoa may each be fitted with not more than four **windows** of any material. If fitted, no dimension of any **window** shall be more than 1500mm in any direction and any edge of any **window** shall be not less than 80mm from the nearest **sail edge**.
- (c) **Sails** may have **primary reinforcement** of any flexible material or coating at a corner, at Cunningham holes and at reefing points and **secondary reinforcement** of additional layers of ply. Such **primary** and **secondary reinforcements** shall be capable of being folded in any direction without damaging the fibers.

#### G.2.2 RULES

**Sails** shall comply with the **class rules** in force at the time of **certification**.

#### G.2.3 CERTIFICATION

- (a) J/24 **sail certification control** is event driven. The **sail certification mark** shall be event specific and may be part of the **event limitation mark**.
- (b) A class measurer shall **certify sails** near the **tack** (**spinnakers** near the **tack/clew**) adjacent to the royalty label and shall initial and date over the **certification mark** and the royalty label.
- (c) Once a **sail** has been **certified** at an event, it need not be **certified** at another event unless it has been altered. Additional **event limitation marks** shall be added to the **sail** for any events in which **event limitation marks** are used.

#### G.2.4 SAILMAKER

- (a) No licence is required.

#### G.2.5 ICA SAIL ROYALTY LABEL

- (a) Each **sail** shall have a numbered ICA royalty label stitched near the **tack point** (**spinnakers** near the **tack/clew**).
- (b) ICA royalty labels are available from the class office.
- (c) ICA royalty labels shall not be transferred from one **sail** to another.

### G.3 MAINSAIL

#### G.3.1 IDENTIFICATION

- (a) The class insignia shall be blue, between 300mm and 320mm wide and between 635mm and 645 mm high and in conformance with the diagram below and be located in accordance with the RRS.

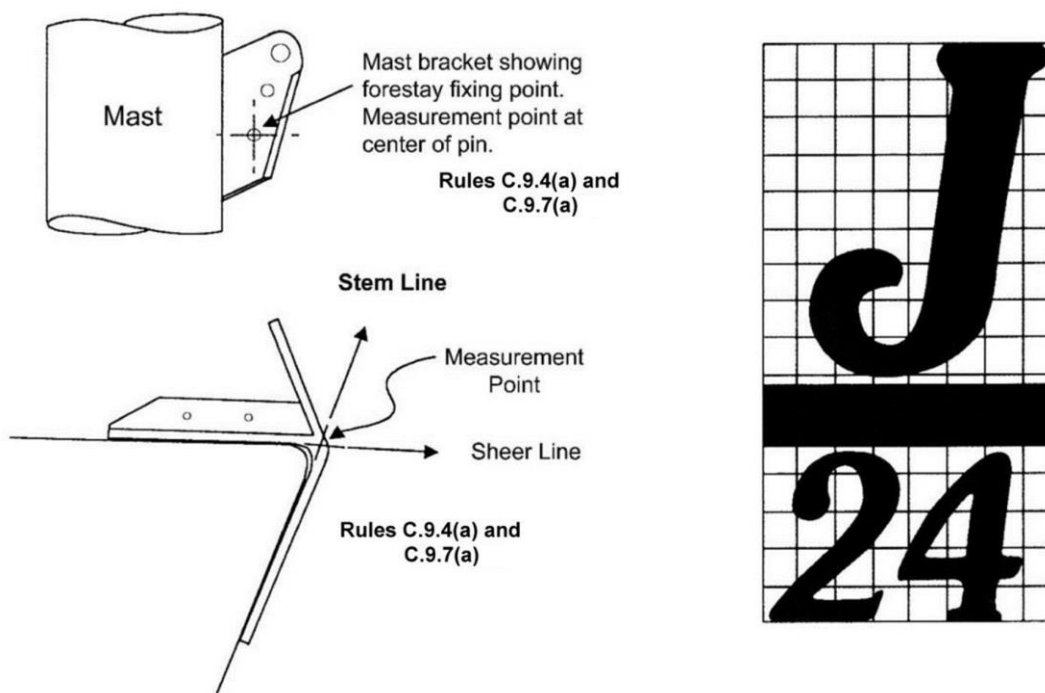

#### G.3.2 MATERIALS

- (a) The **ply** fibres shall consist of a single **woven ply** of polyester of at least 260 grams per square meter, except for a foot shelf not exceeding 300mm in width.
- (b) **Battens** shall be made of fiberglass
- (c) The headboard may be made of any material.

#### G.3.3 CONSTRUCTION

- (a) The construction shall be: **soft sail, single ply sail.**
- (b) The **body of the sail** shall be made of the same **woven ply** throughout.
- (c) Reef points are optional.
- (d) The following are permitted: Stitching, glues, tapes, bolt ropes (required), corner eyes, headboard with fixings, Cunningham eye or pulley, **batten pocket patches, batten pocket elastic, batten pocket end caps**, leech line with cleat, **windows** consistent with G.2.1(b), tell tales, sail shape indicator stripes and items as permitted or prescribed by other applicable *rules*.
- (e) Not in use.
- (f) The **mainsail** shall be indelibly stamped in the **head** by the sailmaker with the following:

“This **sail** has been manufactured to comply with J/24 **class rules**. Only materials in accordance with **class rule** G.3.2 have been used.

Signed: \_\_\_\_\_

Date: \_\_\_\_\_

Loft: \_\_\_\_\_”

(g) The **mainsail** shall be attached to the **mast** and **boom** with boltropes

#### G.3.4 DIMENSIONS

	minimum	maximum
<b>Leech length</b>		9170mm
<b>Quarter width</b>		2600mm
<b>Half width</b>		1980mm
<b>Three-quarter width</b>		1175mm
<b>Top width</b>		150mm
Headboard		115mm
Mass of <b>ply</b> of the <b>body of the sail</b>	260 g/m <sup>2</sup>	
<b>Head point</b> to centreline of top <b>batten pocket</b> at the <b>leech</b>	1775mm	
<b>Clew point</b> to centreline of bottom <b>batten pocket</b> at the <b>leech</b>	1775mm	
<b>Foot</b> boltrope length	2300mm	
Top batten length		610mm
Intermediate batten length (a maximum of 2 are permitted)		990mm
Bottom batten length		740mm
Batten width		50mm

### G.4 HEADSAIL-GENOA

#### G.4.1 MATERIALS

- (a) The **ply** fibres shall consist of either a single **woven ply** of polyester, or a single **laminated ply** of mylar film with HPME or aramid fibers. The genoa **headsail** shall not weigh less than 5.5kg, weighed dry without sailbag or any rigging. No abnormal distribution of **sail** materials or abnormal components shall be used to increase the weight to satisfy this rule.
- (b) **Sail reinforcement** shall consist of **woven ply** polyester or **laminated ply** of mylar film with HPME or aramid fibers.

#### G.4.2 CONSTRUCTION

- (a) The construction shall be: **soft sail, single ply sail**.
- (b) The **body of the sail** shall be made of the same **woven ply** or **laminated ply** throughout.
- (c) The **leech** shall not extend beyond a straight line from the **aft head point** to the **clew point**.
- (d) The following are permitted: Stitching, glues, tapes, corner eyes, Cunningham eye or pulley, hanks, **leech** line with cleat, **windows** consistent with G.2.1(b), cringle or eye in the **foot** for a tacking line, tell tales, **sail** shape indicator stripes and items as permitted or prescribed by other applicable *rules*.
- (e) Genoas made of laminated materials shall have a woven material patch fixed near the **tack point** upon which the class royalty label shall be stitched and the **sail** may receive a **certification mark**.

- (f) The genoa **headsail** shall be indelibly stamped in the **head** by the sailmaker with the following:

“This **sail** has been manufactured to comply with J/24 **class rules**. Only materials in accordance with **class rule** G.4.1 have been used.

Signed: \_\_\_\_\_

Date: \_\_\_\_\_

Loft: \_\_\_\_\_”

#### G.4.3 DIMENSIONS

	minimum	maximum
<b>Luff length</b>	8100mm	8460mm
<b>Luff Perpendicular</b>	4180mm	4345mm
<b>Top width</b>		95mm
<b>Hanks – distance between centrelines</b>	450mm	
<b>Hanks - width, if cloth</b>		40mm
<b>Window</b> (up to 4) between any 2 points		1500mm

### G.5 HEADSAIL - JIB

#### G.5.1 MATERIALS

- (a) The **ply** fibres shall be of woven polyester of at least 260 grams per square meter.
- (b) **Battens** shall be made of fiberglass.

#### G.5.2 CONSTRUCTION

- (a) The construction shall be: **soft sail, single ply sail**.
- (b) The **body of the sail** shall consist of the same **woven ply** throughout.
- (c) The following are permitted: 3 Battens, Stitching, glues, tapes, corner eyes, Cunningham eye or pulley, hanks, leech line with cleat, windows consistent with G.2.1(b), cringle or eye in the foot for a tacking line, tell tales, sail shape indicator stripes and items as permitted or prescribed by other applicable rules.
- (d) The jib **headsail** shall be indelibly stamped in the **head** by the sailmaker with the following:

“This **sail** has been manufactured to comply with J/24 class rules. Only materials in accordance with class rule G.5.1 have been used.

Signed: \_\_\_\_\_

Date: \_\_\_\_\_

Loft: \_\_\_\_\_”

- (e) The **leech** may be straight, concave or convex. It shall deviate from a straight line from the **aft head point** to the **clew point** by no more than 40mm.

#### G.5.3 DIMENSIONS

	minimum	maximum
<b>Luff length</b>	7845mm	8300mm
<b>Luff Perpendicular</b>	2785mm	2895mm
<b>Top width</b>		95mm
Weight of <b>ply</b> of the <b>body of the sail</b>	260g/m <sup>2</sup>	

	minimum	maximum
<b>Hanks – distance between centerlines</b>	450mm	
<b>Hanks - width, if cloth</b>		40mm
<b>Top batten length</b>		450mm
<b>Middle and lower batten length</b>		600mm
<b>Batten width</b>		50mm

## G.6 SPINNAKER

### G.6.1 MATERIALS

- (a) The **ply** fibres shall consist of woven nylon not less than 40 grams per meter squared.
- (b) **Sail reinforcement** shall consist of nylon or woven polyester.

### G.6.2 CONSTRUCTION

- (a) The construction shall be: **soft sail, single ply sail**.
- (b) The **body of the sail** shall consist of the same **woven ply** throughout.
- (c) The following are permitted: Stitching, glues, tapes, corner eyes, recovery line eyes, tell tales and items as permitted or prescribed by other applicable *rules*.
- (d) The spinnaker shall be a trilateral **sail**, symmetrical about its vertical centreline.
- (e) The spinnaker shall be indelibly stamped in the **head** area by the sailmaker with the following:

“I certify that this **sail** has been manufactured to comply with J/24 **class rules**. Only materials in accordance with **class rule** G.6.1 have been used.

Signed: \_\_\_\_\_

Date: \_\_\_\_\_

Loft: \_\_\_\_\_”

### G.6.3 MEASUREMENT AND DIMENSIONS

- (a) The spinnaker shall be measured while folded in half about its vertical centreline with the **leeches** superimposed.
- (b) The half height half width shall be the measurement taken in a straight line between a point on the **leech** 4060mm from the top of the **head** and a point on the centerline 4060mm from the top of the **head**.
- (c) The three-quarter height half width shall be the measurement taken in a straight line between a point on the **leech** 2030mm from the top of the **head** and a point on the centreline 2030mm from the top of the **head**.

	minimum	maximum
Top of the <b>head</b> to the <b>clew points</b>	7930mm	8130mm
Half <b>foot length</b>	2300mm	2600mm
<b>Foot Median</b>	8600mm	9600mm
Half height half width	2540mm	2610mm
Three-quarter height half width	1600mm	

# PART III – APPENDICES

## **Section H – Event Rule Change Options**

### **H.1 GENERAL GUIDANCE**

Except for H.6, these rules must be invoked individually by the sailing instructions per RRS 87. The default is that these rules do not apply. The notice of race shall state that “**Class rule** (XYZ) will be changed in the sailing instructions to H.(X) or (description of a special change)”. The same must be stated in the sailing instructions. The options described here in Section H are a part of these **class rules** and do not need ICA approval for their inclusion in an event. Any other changes to **class rules** (description of a special change) requires the approval of the ICA.

### **H.2 SPARE SPINNAKER**

**Class rule** C.10.2 may be changed per RRS 87 to allow a **boat** to carry a spare class spinnaker on board while racing for a specific event subject to the following:

- (a) The spare spinnaker must be so designated at event inspection, and may be marked by a special **event limitation mark** by the Technical Committee or the event inspectors.
- (b) The spare spinnaker may only be used after the primary spinnaker has been damaged to the point that it cannot be effectively repaired with sail tape while afloat. Approved damage would include tears over a meter long or beyond a single panel.
- (c) If the spare spinnaker is used, a **boat** shall submit written notice to the race committee at the race office within the protest time limit.
- (d) The damaged primary spinnaker shall be presented to the Technical Committee or the race committee for examination. If the damage does not meet the requirements of H.2(b), the race committee shall impose a scoring penalty of 20%, as calculated by RRS 44.3(c) to the races in which the spare spinnaker was used, without a hearing.
- (e) If the primary spinnaker is able to be repaired, it shall be returned to service as the primary spinnaker. If the primary spinnaker is unable to be repaired and returned to use, the spare spinnaker shall be used for the remainder of the regatta, unless that sail is also subsequently lost or damaged beyond repair.

### **H.3 LEGS-IN CREW POSITIONING**

(Option for team-racing, match-racing, frostbiting, and provided-boat events).  
**Class rule** C.2.2(b) is replaced with the following: “While seated on the deck, **crew** shall have their legs inboard of the **sheerline**.”

### **H.4 CREW LIMITATIONS This changes Class rule C.2.1**

H.4.1 Total **crew** weight (in swim wear) shall not exceed 340kg.

H.4.2 A **crew** nominated or listed for this event shall remain the same throughout the event. Emergency changes may be made only with written permission of the race committee.

H.4.3 A **crew** nominated or listed for this event may be different for different days only if scheduled in advance at registration. Emergency changes may be made only with written permission of the race committee.

#### **H.5 JIB ONLY**

The event will be sailed with three sails. A jib as described in **class rule G.5** shall be the only **headsail** permitted while racing.

#### **H.6 HANDICAP RACING**

- (a) All limitations on **crew** numbers, substitution and weight are eliminated for handicap racing events.
- (b) **Sails** used for handicap racing must comply with **class rules** for dimensions and materials, but will not be limited in number.

#### **H.7 RACING WITHOUT ENGINE**

The event will be raced without an engine. The Boat weight in dry condition including all portable equipment, but excluding sails and personal equipment is changed to minimum 1318 kg. The OA must state the specific reason(s) for the request. Executive Committee (EC) approval is required.

Effective Date: 17<sup>st</sup> May 2023

Published Date: 17<sup>th</sup> May 2023

Previous issues: 1<sup>st</sup> March 2022, 2<sup>nd</sup> March 2021

© *World Sailing* 2023